

BRUNTON AXIS TRANSIT INSTRUCTION MANUAL

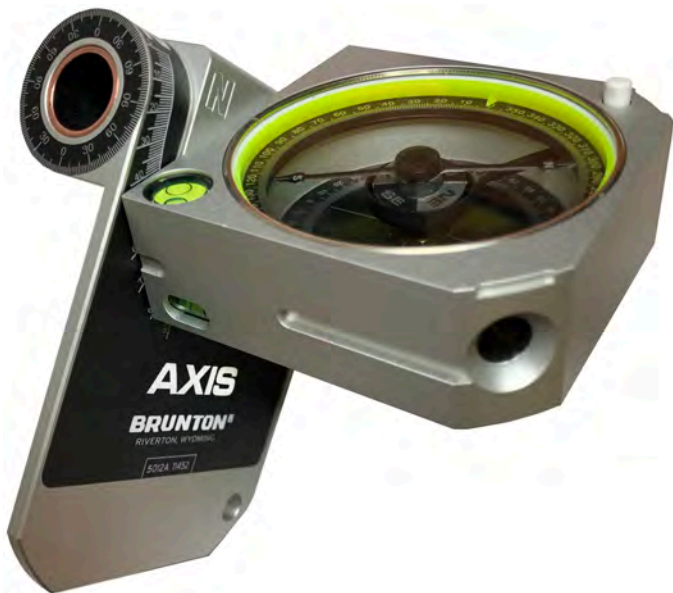

EVERY ANGLE, EVERY DIRECTION

SPECIFICATIONS:

Azimuth Graduated Ring: **MODEL F-5012**

Quadrant Graduated Ring: **MODEL F-5011**

MAGNETISM: NdFeB rare earth magnet on sapphire jewel suspension; high visibility north and south markings; induction damping for quick stabilization

Dimensions (Closed): **3.92" X 2.78" X 1.18"**

Weight: **13 OZ.**

Compass Bearing Accuracy: **$\pm 1/2^\circ$ WITH 1° GRADUATIONS**

Inclinometer Accuracy: **$\pm 1/2^\circ$ WITH 1° GRADUATIONS**

Dip Angle Accuracy: **$\pm 1^\circ$ WITH 2° GRADUATIONS**

Plunge Angle Accuracy: **$\pm 1/2^\circ$ WITH 1° GRADUATIONS**

TABLE OF CONTENTS

- 1- Introduction
- 2- Caring for your Transit
- 3- Component Diagrams and Configurations
- 4- Magnetic Declination
- 5- Measuring Horizontal Bearings
- 6- Measuring Vertical Inclination
- 7- Measuring Strike and Dip of a Plane
- 8- Measuring Dip and Dip Direction
- 9- Measuring Trend and Plunge of a Line
- 10- Other Measurements
- 11- Reference Material
- 12- The Axis Story
- 13- Warranty and Service Information
- 14- Accessories

1- INTRODUCTION

Congratulations on your purchase of the best pocket transit in the world! The Axis Transit was invented by two geology educators in 2014 with the goal of creating a more intuitive, user-friendly, efficient measurement device. The Axis can measure planes, lines, bearings, and angles each with only one configuration instead of the two to three required by previous pocket transit models, increasing measurement efficiency and decreasing the chance for errors. With its novel compass north orientation and revolutionary dual-axis hollow hinge, the Axis does not require the use of mirrors or bubble levels to sight landmarks, nor does it require the help of additional objects such as notebooks or map boards to extend measurement surfaces. Its measurement configurations help visualize the geometry of what is being measured, making the Axis an excellent teaching tool. It is therefore easier to learn how to use, more intuitive to teach with, and more efficient for students as well as seasoned professionals to use in the field.

FIGURE 1



2 - CARING FOR YOUR TRANSIT

Even though all Brunton pocket transits are made to withstand the rigors of many years of outdoor use, care must be taken to ensure the long life of your instrument:

- Avoid impacts, dropping, extreme temperatures, submersion, and scratches.
- Make sure that the compass face is in its starting position before closing the lid.
- To help protect your transit, always store and carry it in its case when not in use. Brunton recommends placing the Axis in its case with the base against the snap (Figure 1) to avoid scratching the lid decal.
- After heavy field use, or gritty conditions, carefully wipe clean of dirt and dust, and use compressed air to clean hinges and buttons.
- For any further maintenance, decal replacement, needle balancing, or repair, contact Brunton for service (see Part 13).
- Only use a 3/32" hex wrench for adjusting main axis hinge tension and be careful not to overtighten. Tighten in small increments!
- This is a precision instrument - handle it with care.

3 - COMPONENT DIAGRAMS AND CONFIGURATIONS

FIGURE 2: Diagram of closed lid



FIGURE 3
Main Diagram of Axis components A through L

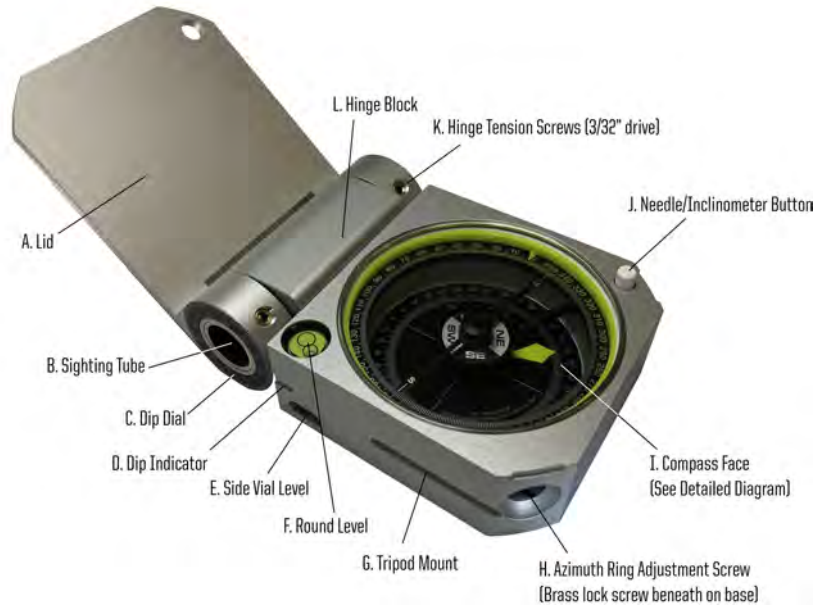
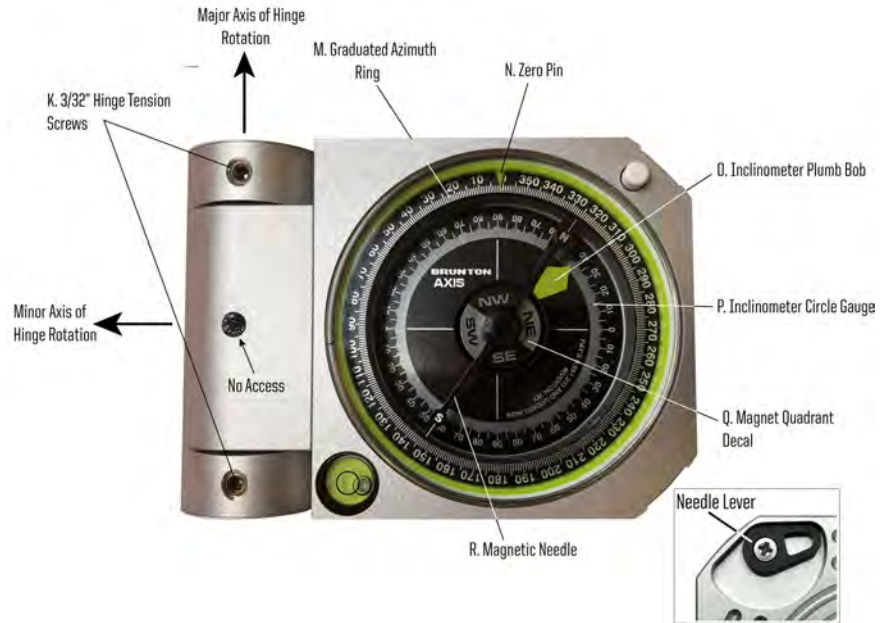

FIGURE 4
Diagram of compass face components M through R and inset photo of needle lever on base



A. LID (FIG. 3)

The Axis lid can rotate around its major and minor axes, and its outer surface can be placed against planar surfaces or used to extend planes for measurement. The outer edge of the lid can also be placed against lineations for measurement of trend and plunge. The top surface of the lid holds the protractor with 1° increments for measurements of plunge or vertical angle.

B. SIGHTING TUBE (FIG. 3)

Use to sight objects for bearing or inclinometer measurements. The major axis of lid rotation goes through this sighting tube.

C. DIP DIAL (FIG. 3)

Both ends of the hollow sighting tube have a dip dial with 2° increments for measuring dip angle.

D. DIP INDICATOR (FIG. 3)

Dip dial increments should be measured where they match the **TOP** of this milled tick mark when the lid is in standard configuration (Figures 5 and 6). They should be read where they match the **BOTTOM** of this tick mark when the lid is in alternate configuration (Figures 7 and 8).

E. SIDE VIAL LEVEL (FIG. 3)

There are small vial levels on both sides of the compass block to allow leveling of the compass face when the round level is not visible.

F. ROUND LEVEL (FIGS. 3 and 4)

The main round level on the compass face should be your default indicator for leveling the compass face to ensure accurate magnetic needle readings.

G. TRIPOD MOUNT (FIG. 3)

Grooves on both sides of the compass body are for attaching to a Brunton ball and socket tripod mount.

H. AZIMUTH RING ADJUSTMENT SCREW (FIG. 3)

Use a screwdriver, paper clip, or dime to turn the large black screw **AFTER** you loosen the small brass screw on the compass base. Be sure to only turn this brass screw one rotation to avoid losing it! This black adjustment screw turns the main azimuth ring to set for declination or to reconfigure 90° for dip/dip direction readings (if this is preferred instead of strike and dip).

I. COMPASS FACE (FIG. 3, DETAIL IN FIG. 4)

See various components in Figure 4.

J. NEEDLE/INCLINOMETER BUTTON (FIGS. 3 and 4)

On the Axis, this button has two functions. In its default setting, the magnetic needle (R) is always locked. Pressing the needle button releases the magnetic needle and allows it to adjust to a new direction. Releasing the needle button locks the magnetic needle back into place or convenient readings.

J. (Continued) It is recommended that you slowly press and release the button **THREE TIMES** for new measurements to allow the magnetic needle to accurately adjust and settle in its new direction. When the Axis compass face is vertical and is being used to measure vertical angles, this button can be pressed and held to keep the inclinometer plumb bob (O) in place long enough for a reading. The needle button can be disengaged by rotating the black needle lever on the compass base (see inset photo in FIG. 4).

K. HINGE TENSION SCREWS (3/32" DRIVE) (FIG. 3 and 4)

There are two user-maintainable set screws that can be used to change the friction on the lid major axis rotation. Be careful not to over tighten them and adjust in very small increments (1/16 - 1/8 of a turn).

L. HINGE BLOCK (FIG. 3)

This piece houses the major and minor axes. When the lid is rotated around the minor axis, inscribed indicators "N" and "S" are visible on the inside of the hinge block. These indicate which end of the magnetic needle (R) to read during trend (plunge direction) measurements.

M. GRADUATED AZIMUTH RING (FIG. 4)

The 1° increments around this declination-adjustable ring are for directional bearing measurements. This is a direct-reading compass, so the bearing is read wherever the N or S seeking end of the magnetic needle (R) meets the graduated ring. The Axis is available with graduated rings in azimuth format (0-360°) and quadrant format (0-90° in NE, SE, SW, NW quadrants). **NOTE THAT THE AXIS IS UNIQUE IN THAT NORTH IS ALIGNED ALONG THE MAJOR AXIS AND SIGHT TUBE IN ITS DEFAULT SETTING.**

N. ZERO PIN (FIG. 4)

This is the pointer used for magnetic declination adjustments (Part 4) or when setting the ring for dip and dip direction readings. Its default setting is at 0° or due north on the graduated ring (M).

O. INCLINOMETER PLUMB BOB (FIG. 4)

This bright yellow-green plumb bob is a gravity-driven way of measuring inclination, or vertical angle, when the compass face is vertical. It can be held in place by pressing and holding the needle/inclinometer button (J).

P. INCLINOMETER CIRCLE GAUGE (FIG. 4)

All around the inner compass base is a versatile inclinometer gauge with 1° increments for measuring vertical angles. The inclinometer gauge is oriented in alignment with the sighting tube, so that when the compass face is held vertically and objects are sighted through the tube, the clinometer plumb needle will orient itself to the correct vertical angle.

Q. MAGNET QUADRANT DECAL (FIG. 4)

This decal is fixed on the magnetic needle and can be used to identify the general dip direction of the lid by quadrant.

R. MAGNETIC NEEDLE (FIG. 4)

The Axis needle is a rare earth, cast NdFeB magnet, which allows it to seek north and come to a complete rest in a minimum of amount of time. In its default setting, the magnetic needle is always locked, and can be released for readjustment by pressing the needle button (J). It is recommended that you slowly press and release the needle button **THREE TIMES** to allow for accurate needle readjustment and bearing readings.

FIGURE 5

STANDARD CONFIGURATION (closes on top) of the Axis lid, rotating around the **MAJOR AXIS**.

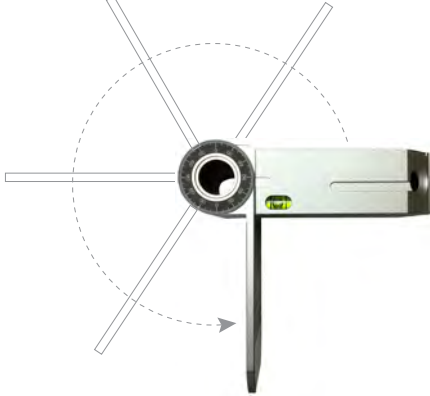

FIGURE 6

In **STANDARD CONFIGURATION**, read the dip dial where its mark aligns with the **TOP** of dip indicator.



FIGURE 7

ALTERNATE CONFIGURATION (closes on the base) of the Axis lid, rotating around the **MAJOR AXIS**.

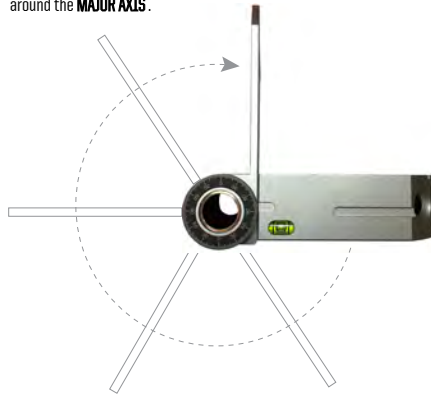

FIGURE 8

In **ALTERNATE CONFIGURATION**, read the dip dial where its mark aligns with the **BOTTOM** of dip indicator.

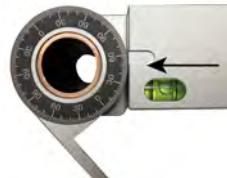

FIGURE 9

Rotation of lid/compass face around **MINOR AXIS**, with detail showing where to read plunge or vertical angle on the lid protractor where it intersects the top of the compass face. In this configuration the **N** inside the hinge block indicates that the **NORTH-SEEKING** end of the magnetic needle should be read for trend (plunge direction) measurements.

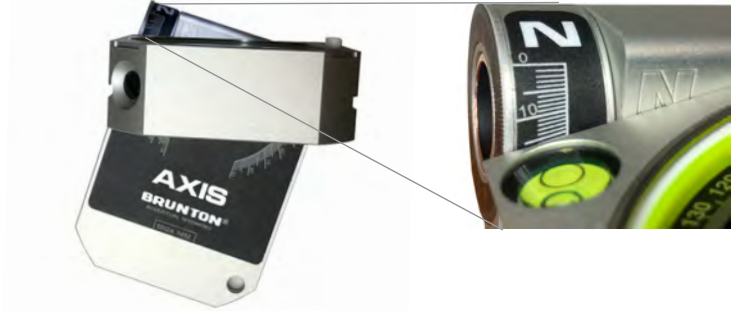

FIGURE 10

Rotation of lid/compass face around **MINOR AXIS**, with detail showing where to read plunge or vertical angle on the lid protractor. In this configuration the **S** inside the hinge block indicates that the **SOUTH-SEEKING** end of the magnetic needle should be read for trend measurements.

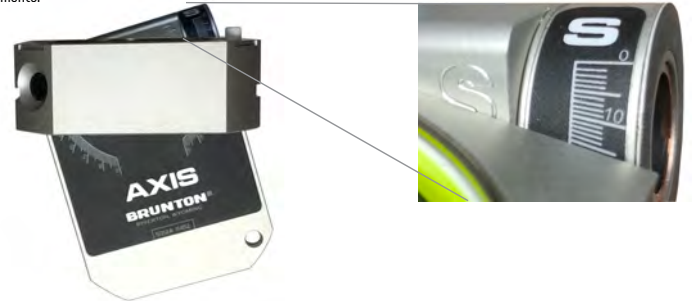

FIGURE 11

Rotation of lid/compass face around **MINOR AXIS** into **INVERTED POSITION** for lineations on overhanging surfaces. Detail shows where to read angle on lid protractor, where it meets the **BOTTOM** of the compass face. The **N** inside the hinge block indicates that the **NORTH-SEEKING** end of the magnetic needle should be read for trend measurements.



FIGURE 12

Rotation of lid/compass face around **MINOR AXIS** into **INVERTED POSITION** for lineations on overhanging surfaces. Detail shows where to read angle on lid protractor, where it meets the **BOTTOM** of the compass face. The **S** inside the hinge block indicates that the **SOUTH-SEEKING** end of the magnetic needle should be read for trend measurements.

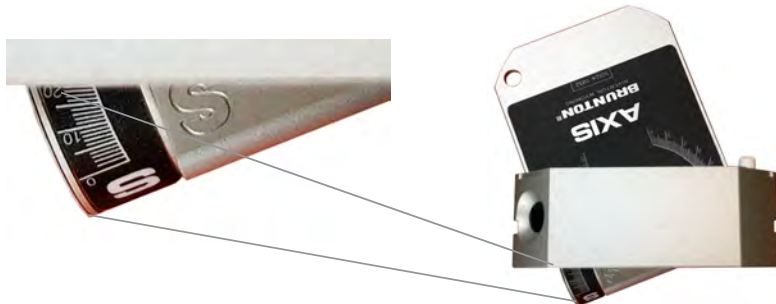

4 - MAGNETIC DECLINATION

The Earth is completely surrounded by a constantly-changing magnetic field, and an unobstructed magnetized object will orient itself with Earth's current magnetic north pole. This is the foundational concept of all magnetic compasses. The magnetic north pole, however, is not located at the geographic North Pole. The angular difference between magnetic north (MN) and geographic north (TN for "true north") is called **MAGNETIC DECLINATION** (or variation). Declination changes with time and location on earth, so it is important to know the current declination for your particular location in order to make accurate compass measurements. Brunton recommends using an online declination calculator such as the National Geophysical Data Center's Declination Calculator.

To ensure accurate compass measurements, you should adjust your pocket transit for magnetic declination **BEFORE** you take any directional bearing measurements. You should make these adjustments every year, and in every new location. Adjustments on the Axis are made by rotating the graduated circle:

1. You first have to unlock the graduated circle by loosening the declination lock screw on the compass base; one full rotation of this brass screw will do (be careful not to fully loosen or it will fall out and be lost forever!).
2. Then rotate the main, black declination adjustment screw on the side corner of the compass block. Begin with the zero pin at 0°.

(FIGURE 13)

- a. For **EAST DECLINATION**, rotate the graduated circle **COUNTER-CLOCKWISE** until the zero pin matches the declination angle. (FIGURE 13)
- b. For **WEST DECLINATION**, rotate the graduated circle **CLOCKWISE**. (FIGURE 13)

FIGURE 13

Magnetic declination adjustments of the graduated circle.

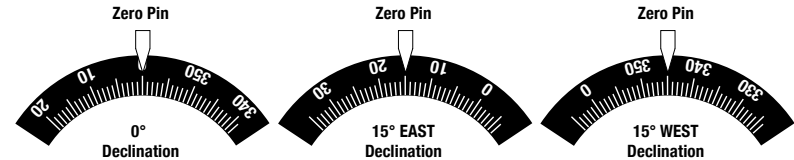

MEASUREMENT METHODS

The measurement, description, and mapping of bearings, angles, planes, and lines is foundational to the geological sciences and many other field-based disciplines. Each section below describes how the Axis Transit can be used to measure these important features in the field. Instructional videos for the Axis can also be found at www.brunton.com.

5 - MEASURING HORIZONTAL BEARINGS

Field professionals often need to measure the bearing, or compass direction, from their location to a specific landmark or destination. This might be for navigation, surveying, or triangulation to pinpoint a location on a map. To measure, record, and map a directional bearing between two points, compass direction, or azimuth, is measured in the horizontal plane. Usually the directional bearing is measured from the point where one is standing to another point in the landscape.

5.1 - AZIMUTH VERSUS QUADRANT BEARING FORMATS

Bearings can be measured and stated in **AZIMUTH FORMAT**, a number from 0 to 360 degrees, or in **QUADRANT FORMAT**, an angle away from North or South in relation East or West. The Axis is available with graduated circles in either Azimuth or Quadrant formats. Regardless of what type of bearing is read off of the compass, these two formats are interchangeable. Converting between the two formats takes practice; the circle in **FIGURE 14** can help provide guidance.

FIGURE 14

Azimuth directions 0-360 on outside of circle, Quadrant directions on inside, with conversion hints between the two formats.

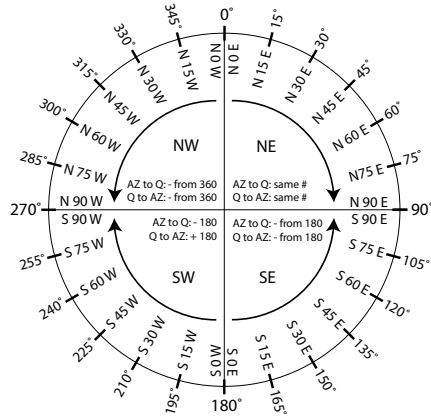

5.2 - DIRECT READING

You may notice that East and West appear to be switched when viewing the compass face. Like other pocket transits, the Axis is a direct reading compass.

- Read a directional bearing where the needle points on the graduated circle, already adjusted for magnetic declination.
- In some configurations you must read the North-seeking end of the needle, and in others the South-seeking. It is important to familiarize yourself with Axis methodologies to avoid reading the wrong end of the needle.

5.3 - BEARING MEASUREMENT METHODOLOGY

The Axis uses a novel hollow sighting tube in its hinge, instead of a mirror, through which features can be directly sighted:

1. Rotate the lid around its main hinge (major axis) until it stops at a 90 degree position. (**FIGURES 15 & 16**)
2. Bring the sighting tube close to your eye, and center the object in the sighting tube. If the feature being sighted is at a similar elevation with eye level, the compass can remain locked around the minor axis. (**FIGURES 15 & 16**)
3. Level the compass face using the side vial level.
4. Press the needle button **THREE TIMES** to allow the needle to realign itself. Let go of the needle release button, and the needle will remain locked in place.
5. If the Axis lid is left of the compass face in **LEFT-HAND** sighting configuration (**FIGURE 15**), you should read the **NORTH-SEEKING** end of the magnetic needle.

FIGURE 15 : **LEFT-HAND** sighting configuration of object level with eye; **NORTH-SEEKING** end of magnetic needle should be read for directional bearing.

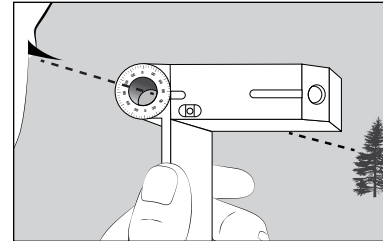

6. If the Axis is held with the lid right of the compass face in **RIGHT-HAND** sighting configuration (**FIGURE 16**), then the **SOUTH-SEEKING** end of the needle should be read.

FIGURE 16 : **RIGHT-HAND** sighting configuration of object level with eye, **SOUTH-SEEKING** end of magnetic needle should be read for directional bearing.

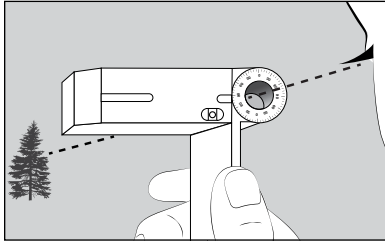

7. If the object being sighted is above or below eye level, the hinge can be rotated around its minor axis until the object is in line with the center of the sighting tube (**FIGURES 17A** and **17B**). The compass face should be level before bearing measurements are made. In this configuration, **HORIZONTAL BEARING** and **VERTICAL INCLINATION** to a particular feature can be simultaneously measured by also using the lid protractor dial (more about this in the next section).

FIGURES 17A AND 17B : Sighting an object above or below eye level in left-hand configuration; compass bearing and vertical angle can be simultaneously measured in this configuration.

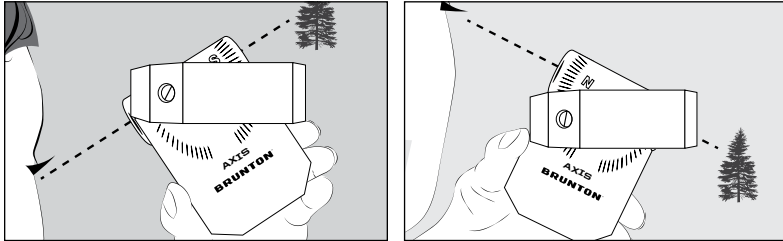

6 - MEASURING VERTICAL INCLINATION

To measure, record, and map an angle of inclination between two points or along a slope, field professionals measure angles in the vertical plane. This measurement is usually performed from a viewer's eye height with a device that measures angle up or down to an object in the landscape. Zero degrees is a horizontal angle and 90 degrees is a vertical angle.

THE AXIS POCKET TRANSIT CAN MEASURE VERTICAL ANGLES USING TWO DIFFERENT CONFIGURATIONS:

1. The first configuration (**FIGURE 18**) involves rotating the compass lid 180 degrees around its minor axis, then closing the lid against the compass base. When holding the compass face and lid **VERTICALLY**, the hollow sighting tube can be used to locate the feature being measured. In this configuration, the clinometer needle is gravity-driven as a plumb needle, and as the compass is placed in increasingly steep angles, the needle corresponds to higher angles on the clinometer dial in the compass face. This needle can be held in place by **PRESSING AND HOLDING** the needle button. Read the inclination where the center of the clinometer needle meets the clinometer circle (1° increments).

FIGURE 18 : Using clinometer plumb needle to measure vertical angle.

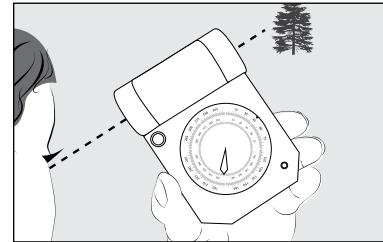

2. The second configuration is the same as in **FIGURES 17A AND 17B**, where the compass rotates around its minor axis and remains at a 90 degree angle with the horizontal compass face. When the object is sighted through the hollow hinge tube and the compass face is leveled, the vertical angle can be read where the lid protractor dial meets the top of the compass face (**SEE FIGURES 9 AND 10**).

7 - MEASURING STRIKE AND DIP OF A PLANE

Planar surfaces are one of the most common features measured and mapped by geologists in the field. Planar surfaces often include bedding planes of layered rock units, faults, joints, axial planes and limbs of folds, and metamorphic foliation. To measure, record, and map the orientation of a tilted plane, such as the bedding plane illustrated in **FIGURE 19**, geoscientists use a horizontal reference plane. **STRIKE** is the directional bearing of the line produced by the intersection between the tilted plane and the horizontal reference plane. The line of strike can have two possible bearings that are 180 degrees from each other. **DIP** is a vertical angle between the tilted plane and the horizontal reference plane. Dip consists of an angle and a singular direction, with dip direction always perpendicular to strike. The complete description of a plane consists of **STRIKE** (bearing), **DIP** (angle) and **DIP DIRECTION** (often a general quadrant is enough). Alternately, **DIP ANGLE AND DIP DIRECTION** can describe the orientation of a plane if the bearing of dip direction is read (see end of section 7).

FIGURE 19 : Strike and dip of a bedding plane surface that is dipping towards the right.

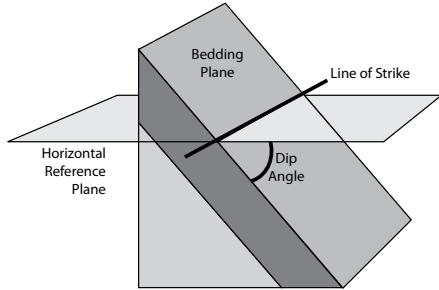

THE AXIS TRANSIT CAN MEASURE THE STRIKE AND DIP OF ANY PLANE WITH A SINGLE COMPASS CONFIGURATION:

1. The first step is to place the top of the Axis lid against the planar surface to be measured (**FIGURE 20A**). If the surface is too small or not expressed as a flat surface, the compass lid can be used to extend or create the measurement plane (**FIGURE 20B**).

The lid can also be rotated 180 degrees around its minor axis to the alternate configuration, then the lid can be placed against the top or bottom of a planar surface for measurement (**FIGURES 21A AND 21B**). This configuration is especially helpful for extending and measuring overhanging planar surfaces.

FIGURES 20A AND 20B : Measurement of strike and dip of a plane in **standard configuration**, using lid to average or extend a planar surface.

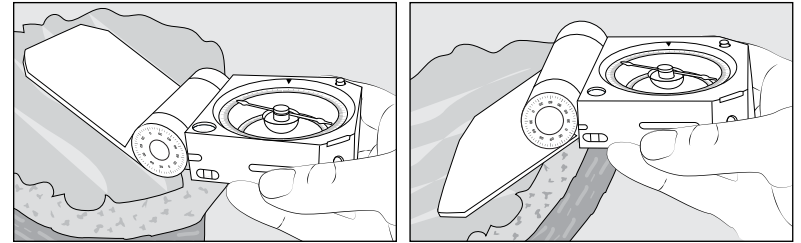

FIGURES 21A AND 21B : Measurement of strike and dip of a plane in **alternate configuration**, using lid to average or extend a planar or overhanging surface.

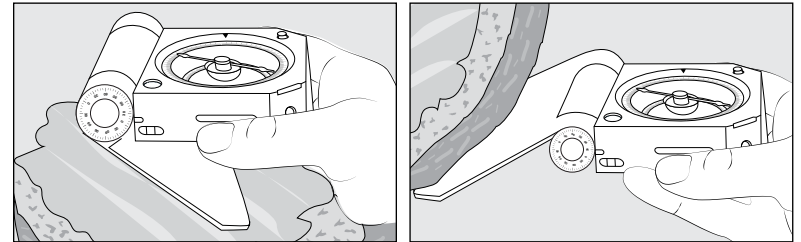

2. Once the lid has been placed along the planar surface to be measured, level the compass face using the round level and side vial levels if needed. Do not rotate the compass around its minor axis to level it; instead move the lid around the major (hollow hinge) axis and swivel the lid upon the measurement surface itself.
3. When the compass face is leveled, press the needle release button **THREE TIMES** to allow the magnetic needle to readjust and settle. Let go of the button, and the needle locks in place.
4. **STRIKE** can be read off of **EITHER END** of the magnetic compass needle.

5. **DIP ANGLE** can be read off of the dials on either side of the hollow hinge, but you must make sure you are reading the dip mark correctly. When the lid is in standard configuration (FIGURES 20A AND 20B), read the dip dial mark where it meets the **TOP** of the inscribed dip indicator (SEE FIGURE 6). When the lid is in alternate configuration (FIGURES 21A AND 21B), read the dip dial mark where it meets the **BOTTOM** of the dip indicator (SEE FIGURE 8).

6. **DIP DIRECTION** can be approximated by looking at the magnet quadrant decal and noting the general quadrant (NW, SW, SE, NE) direction towards which the plane is dipping downwards (the direction water would flow down the plane).

IF DIRECT CONTACT WITH A MEASUREMENT SURFACE IS IMPOSSIBLE OR IF THE SURFACE IS TOO IRREGULAR, THE AXIS CAN ALSO BE USED TO SIGHT STRIKE AND DIP FROM A DISTANCE.

1. Align yourself along strike of the plane you are measuring. The "disappearing plane" method is a simple way to ensure you are in line with strike; move laterally until the plane disappears into only a line from your viewpoint.
2. Hold the Axis at eye level, sighting the line of strike through the sighting tube. (FIGURE 22)
3. Level the compass face using the side vial level that is visible. Press the needle button three times.
4. Rotate the lid until it aligns with the plane being measured. (FIGURE 22)
5. **DIP ANGLE** can be read off of the appropriate hinge dial-indicator alignment.
6. **STRIKE** can be read once you move the Axis away from your eye.
7. **DIP DIRECTION** can be approximated from the magnetic needle orientation in relation to the plane's down-dip direction.

FIGURE 22 : Sighting method for measuring the orientation of a plane from a distance.

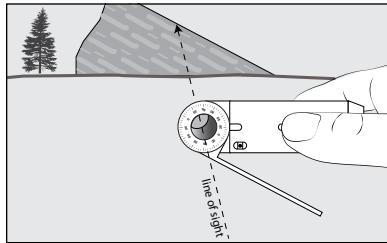

8 - MEASURING DIP AND DIP DIRECTION

1. If this is your preferred way of measuring planar orientation, you must **FIRST** adjust the azimuth ring a full 90 degrees to the east, or to the right and clockwise using the black adjustment screw. Also keep magnetic declination in mind and add or subtract the appropriate number of degrees east or west. For example, if declination is 10° E, rotate the ring until 100° (0-360) or S80E (quadrant) meets the ZERO PIN (N). (See FIG. 23)
2. Then use the same configurations as above (Figs. 20,21, 22) for contact or sighting methods. The dip angle is read in the same way, and dip direction is taken from a direct reading of the magnetic needle. If the plane is dipping **AWAY** from the compass body, or to the right in FIG 23, read the N-seeking end of the needle. If the plane is dipping **TOWARDS** the compass body, or to the left in FIG 23, read the S-seeking end of the needle.

FIGURE 23: Dip and Dip Direction Configuration - Rotate a full 90 degrees +/- magnetic declination
This example is set to 100 degrees at the zero pin to account for 10 degrees of E declination

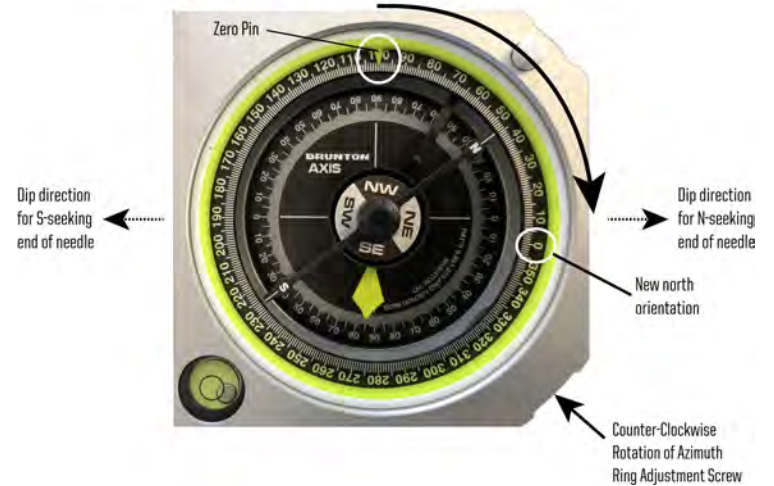

9 - MEASURING TREND AND PLUNGE OF A LINE

Lines, or lineations, (FIGURE 24) are another common feature measured and mapped by geologists in the field. Geological lineations can include fault slickenlines, erosional grooves, current ripple marks, metamorphic crenulations, fold axes, and mineral alignments from flow banding or tectonic strain. To measure, record, and map the orientation of a line or lineation, geoscientists measure structures in reference to the vertical plane. **TREND**, or plunge direction, is the directional bearing of the vertical plane that intersects the lineation. Trend has a singular direction if the line is non-horizontal, with trend pointing in the direction that the lineation plunges down. **PLUNGE** is a vertical angle between the lineation and the horizontal plane, measured in the vertical plane of trend. Plunge only consists of an angle because trend already states the direction of the lineation. The complete description of the lineation consists of **TREND** (bearing, plunge direction) and **PLUNGE** (angle).

FIGURE 24: Trend (plunge direction) and plunge of a lineation (lines on the planar surface)

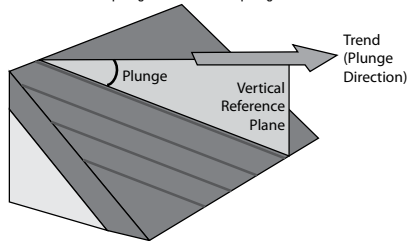

THE AXIS TRANSIT CAN MEASURE THE TREND AND PLUNGE OF ANY LINEATION WITH A SINGLE COMPASS CONFIGURATION.

1. The first step is to rotate the lid around its major axis until it can go no further, and it rests at a 90 degree angle with the compass face.
2. Then place the far edge of the lid along the lineation to be measured (FIGURES 24 AND 25), parallel to the lineation.
3. Rotate the compass face around the minor axis until level, as indicated by the round bubble level, keeping the 90 degree angle with the lid. When the compass face is level in this configuration, the lid forms the vertical plane intersecting the lineation.
4. **PLUNGE** can be read off of the lid protractor where it intersects the compass face (SEE FIGURES 9 AND 10).
5. **TREND** can be read from the end of the compass needle designated by the **N** or **S** that is visible inside the hinge block in its particular configuration. Make sure you press the needle release button three times to allow the compass needle to reset itself. Letting go of the button will allow the needle to lock into place.

FIGURE 25

Measurement of a lineation plunging to the right. Plunge is read where the lid protractor intersects the top of the compass face. Trend is read from the **NORTH-SEEKING** end of the needle in this configuration (the **N** inside the hinge block is a reminder of which end of the needle to read).

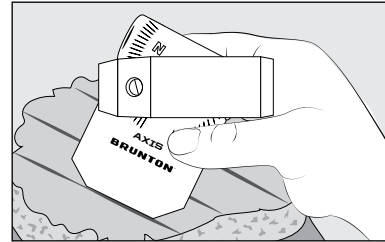
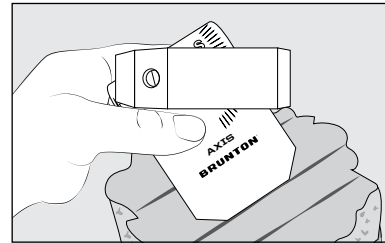

FIGURE 26

Measurement of a lineation plunging to the left. Plunge is read where the lid protractor intersects the top of the compass face. Trend is read from the **SOUTH-SEEKING** end of the needle in this configuration (the **S** inside the hinge block is a reminder of which end of the needle to read).



To measure lineations on overhanging surfaces, the same methods apply, except the lid should be rotated fully around its minor axis into its **INVERTED POSITION**, and the plunge angle should be read where the bottom of the compass face meets the lid protractor dial (SEE FIGURES 11 AND 12). The exposed **N** or **S** in the hinge block again indicates which end of the compass needle to read.

10- OTHER MEASUREMENTS

RAKE (PITCH)

Lineations along a planar surface can also be measured using **RAKE** (also known as pitch). This is the angle between the line of strike and the lineation, in the plane of measurement.

1. To measure rake with the Axis, hold the compass face level with the line of strike. This can be done by holding the side of the compass face on the planar surface, then leveling the compass face.
2. Rotate the compass lid until it aligns with the lineation (FIGURE 27). The Axis can be held in multiple configurations to measure rake.
3. Read the angle off of the dip dial.

FIGURE 27 : One of many possible configurations for measuring rake with the Axis.

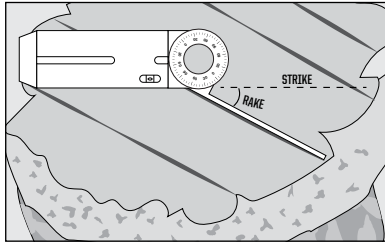

FOLD GEOMETRIES AND CONJUGATE FRACTURES

The Axis can efficiently measure angles between fold limbs, conjugate fractures, deformation bands, and any other features that create angles on surfaces.

1. Hold the side of the Axis against the measurement surface, and align the compass base and lid with the features being measured (FIGURE 28).
2. Read the angle off of the dip dial.

FIGURE 28: Using the Axis as a field protractor to measure angles between fold limbs (pictured) or conjugate fractures.



11 - REFERENCE MATERIAL

TABLE 10.1 True Dip versus Apparent Dip

True dip	Angle between strike and cross-section profile line															
	80°	75°	70°	65°	60°	55°	50°	45°	40°	35°	30°	25°	20°	15°	10°	5°
10°	10°	10°	9°	9°	9°	8°	8°	7°	6°	6°	5°	4°	3°	3°	2°	1°
15°	15°	14°	14°	14°	13°	12°	12°	10°	10°	9°	8°	6°	5°	4°	3°	1°
20°	20°	19°	19°	18°	18°	17°	16°	14°	13°	12°	10°	9°	7°	5°	4°	2°
25°	25°	24°	24°	23°	22°	21°	20°	18°	17°	15°	13°	11°	9°	7°	5°	2°
30°	30°	29°	28°	28°	27°	25°	24°	22°	20°	18°	16°	14°	11°	9°	6°	3°
35°	35°	34°	33°	32°	31°	30°	28°	26°	24°	22°	19°	16°	13°	10°	7°	4°
40°	40°	39°	38°	37°	36°	35°	33°	31°	28°	26°	23°	20°	16°	12°	8°	4°
45°	45°	44°	43°	42°	41°	39°	37°	35°	33°	30°	27°	23°	19°	15°	10°	5°
50°	50°	49°	48°	47°	46°	44°	42°	40°	37°	34°	31°	27°	22°	17°	12°	6°
55°	55°	54°	53°	52°	51°	49°	48°	45°	43°	39°	36°	31°	26°	20°	14°	7°
60°	60°	59°	58°	58°	56°	55°	53°	51°	48°	45°	41°	36°	30°	24°	17°	9°
65°	65°	64°	64°	63°	62°	60°	59°	57°	54°	51°	46°	42°	36°	29°	20°	11°
70°	70°	69°	69°	69°	68°	67°	65°	63°	60°	58°	54°	49°	43°	35°	25°	13°
75°	75°	74°	74°	74°	73°	72°	71°	69°	67°	65°	62°	58°	52°	44°	33°	18°
80°	80°	80°	79°	79°	78°	78°	77°	76°	75°	73°	71°	67°	63°	56°	45°	26°
85°	85°	85°	85°	84°	84°	84°	83°	83°	82°	81°	80°	78°	76°	71°	63°	45°

TABLE 10.2 Trigonometry Quick Calculations

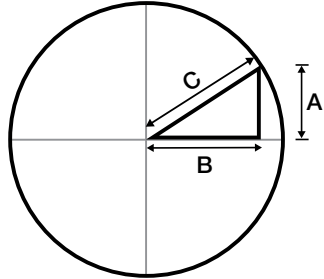

$$\begin{aligned} \text{SIN}(\theta) &= A/C & \text{CSC}(\theta) &= C/A \\ \text{COS}(\theta) &= B/C & \text{SEC}(\theta) &= C/B \\ \text{TAN}(\theta) &= A/B & \text{COT}(\theta) &= B/A \end{aligned}$$

A = Side Opposite Angle θ
 B = Side Adjacent to Angle θ
 C = Hypotenuse

$$C^2 = A^2 + B^2$$

	SINE	TAN
1°	.017	.017
2°	.035	.035
3°	.052	.052
4°	.070	.070
5°	.087	.087
6°	.105	.105
7°	.122	.122
8°	.139	.140
9°	.156	.158
10°	.174	.176
11°	.191	.194
12°	.208	.212
13°	.225	.231
14°	.242	.249
15°	.259	.268

	SINE	TAN
16°	.275	.286
17°	.292	.306
18°	.309	.325
19°	.325	.344
20°	.342	.364
21°	.358	.384
22°	.375	.404
23°	.390	.424
24°	.407	.445
25°	.423	.466
26°	.438	.488
27°	.454	.509
28°	.469	.532
29°	.485	.554
30°	.500	.577

	SINE	TAN
31°	.515	.601
32°	.530	.625
33°	.545	.649
34°	.559	.674
35°	.573	.700
36°	.588	.726
37°	.602	.753
38°	.615	.781
39°	.629	.810
40°	.643	.839
41°	.656	.869
42°	.669	.900
43°	.682	.932
44°	.695	.966
45°	.707	1.00

GRAPH 10.3

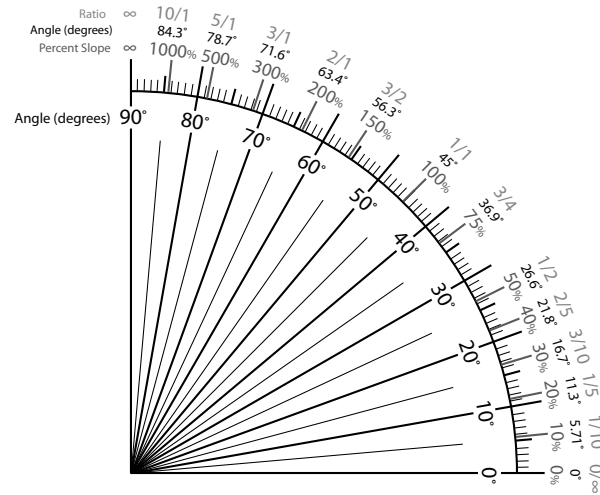

TYPES OF SLOPE GRADIENT

SLOPE CAN BE STATED IN SEVERAL WAYS:

- **ANGLE IN DEGREES** - Shown in black from 0° (horizontal) to 90° (vertical); this is what the Axis clinometer can directly measure
- **PERCENT SLOPE** - Rise/run x 100; shown in percentages; this is most commonly known as "grade" in the transportation, surveying, construction, and engineering worlds
- **RATIO** - 1 part rise: # parts run; rise over run stated as a ratio rather than number; shown in grey on outer edge of diagram

TABLE 10.4

Common Unit Conversions

Inches	Feet	mm	cm
1/8	0.0104	3.1750	3.1750
1/4	0.0208	6.3500	6.3500
3/8	0.0313	9.5250	9.5250
1/2	0.0417	12.700	12.700
5/8	0.0521	15.875	15.875
3/4	0.0625	19.050	19.050
7/8	0.0729	22.225	22.225
1	0.0833	25.400	25.400
2	0.1667	50.800	50.800
3	0.2500	76.200	76.200
4	0.3333	101.60	101.60
5	0.4167	127.00	127.00
6	0.5000	152.40	152.40
12	1.0000	304.80	304.80

Conversions	Conversions
1 inch = 2.54 centimeters	1 centimeter = 10 millimeters
1 foot = 12 inches	1 centimeter = 0.01 meters
1 foot = 0.305 meters	1 centimeter = 0.394 inches
1 yard = 3 feet	1 meter = 100 centimeters
1 yard = 0.914 meters	1 meter = 3.281 feet
1 chain = 66 feet	1 meter = 1.094 yards
1 mile = 5,280 feet	1 kilometer = 1,000 meters
1 mile = 80 chains	1 kilometer = 0.6214 miles
1 mile = 1.609 kilometers	1 hectare = 10,000 meters ²
1 acre = 43,500 feet ²	1 hectare = 2,471 acres
1 acre = 0.4047 hectares	

12 - THE AXIS STORY

The idea of the Axis Transit was first conceived by Lauren Heerschap, a geology instructor in Durango, CO, while teaching field geology to college students. Like most seasoned field geologists, Lauren had learned how to use the standard Brunton transit model as a student, then used it to conduct graduate and professional field research. Teaching new generations of geology students how to use the standard transit model, however, proved quite challenging. Lauren kept wishing that transit measurement methods could be simpler and more intuitive, could visualize the planes and angles being measured, and could take measurements in one configuration without the need for mirrors and extra objects to extend surfaces.

In the fall of 2013 Lauren began sketching out ideas for a new type of transit. Her husband, David Heerschap, a high school geology and physics/engineering teacher and machinist, set out to make Lauren's sketches a reality. They had just set up a home business called Real Science Innovations through which they had already created and sold several new and improved science teaching tools. At home in their garage over the course of the winter, David worked to create a prototype that did what Lauren had envisioned. By the spring of 2014, they had three functional prototypes that could measure planes, lines, bearings, and angles each in one simple configuration. They called the early model the Plane Sight Compass. They initiated the patent process, and in the summer Lauren took the new transit to several college field camps and had her students test it out. They barely needed instruction on how to use it, finding it far more intuitive and easy to measure with, compared to the standard models.

Lauren and David knew the greater geological community would benefit from their new model, but they also realized the limitations of their garage machine shop. They decided to approach Brunton with their idea, knowing the company was best equipped to manufacture and market the new model internationally. Lauren and David retained the patent and have been able to stay involved with the entire process of design, production, and marketing of what is now the Brunton Axis Transit. They have been honored to work with the great Hank Iden, who has been inventing and improving Brunton compasses since 1975 in the Riverton, WY facility. It is a dream come true to see the Axis join the lineup of high-quality precision instruments and hopefully revolutionize how field measurements are made!

13 - WARRANTY AND SERVICE INFORMATION:

Brunton warrants your manufactured product to remain free of defects during the warranty period. Brunton's products are intended to be used in harsh outdoor environments. As such, the Brunton Limited Warranty does not cover normal wear and tear, damage due to misuse or rough handling or chemical exposure, and alteration. Product not registered will not be covered under the Brunton Limited Warranty.

Warranty Period:

The Brunton Limited Warranty is valid for one year from the date of purchase. Products seeking warranty must be accompanied by proof of original purchase and completion of Product Registration on Brunton.com.

Obtaining access to Brunton Limited Warranty:

Requests for warranty may be made by contacting Brunton customer service at 1-800-443-4871 or info@bruntongroup.com.

Should a defect occur in your Brunton branded product which is not due to negligence or by fault or accident, and if the product qualifies for the Brunton Limited Warranty, we shall, at our option, either repair or replace it without charge, and will pay the cost of return shipment to you (you must pay for cost of shipment to Brunton). Refunds are only available for those items purchased directly from Brunton.com within 30 days of purchase.

Limitation of Liability:

BRUNTON SHALL NOT BE LIABLE FOR INCIDENTAL OR CONSEQUENTIAL DAMAGES. THERE ARE NO OTHER EXPRESS WARRANTIES BEYOND THE BRUNTON LIMITED WARRANTY UNLESS MANDATORY LAW PROVIDES OTHERWISE. THESE WARRANTY TERMS ARE SUBJECT TO CHANGE WITHOUT NOTICE.

14 - ACCESSORIES

F-3051 Tripod



F-3040 Ball and Socket



F-3000B Leather case



F-3060 Thimble



Precision Instruments Handmade in Riverton, WY Since 1894
Invented by Real Science Innovations, LLC in Durango, CO in 2014

PROTECTED BY MULTIPLE UTILITY AND DESIGN PATENTS

IN THE UNITED STATES AND AROUND THE WORLD

BRUNTON®

2255 Brunton Court
Riverton, WY 82501
Phone: 800.443.4871
Fax: 303.996.3758
www.brunton.com